

# OLYMPUS®

Your Vision, Our Future

Research Inverted Microscope

## IX83/IX73/IX53

IX3 Series

**NEW**

*Built for Live Cell Imaging*



- OLYMPUS CORPORATION is ISO14001 certified.
- OLYMPUS CORPORATION is FM553994/ISO9001 certified.
- OLYMPUS CORPORATION is MD540624/ISO13485 certified.
- Illumination devices for microscope have suggested lifetimes. Periodic inspections are required. Please visit our website for details.
- All company and product names are registered trademarks and/or trademarks of their respective owners.
- Images on the PC monitors are simulated.
- Specifications and appearances are subject to change without any notice or obligation on the part of the manufacturer.

## OLYMPUS®

**OLYMPUS CORPORATION**  
Shinjuku Monolith, 3-1, Nishi Shinjuku 2-chome, Shinjuku-ku, Tokyo, Japan  
**OLYMPUS EUROPA HOLDING GMBH**  
Wendenstrasse 14-18, 20097 Hamburg, Germany  
**OLYMPUS AMERICA INC.**  
3500 Corporate Parkway, Center Valley, Pennsylvania 18034-0610, U.S.A.  
**OLYMPUS SINGAPORE PTE LTD.**  
491B River Valley Road, #12-01/04 Valley Point Office Tower, Singapore 24837

**OLYMPUS AUSTRALIA PTY. LTD.**  
21 Gilby Road, Mt. Waverley, VIC 3149, Melbourne, Australia  
**OLYMPUS LATIN AMERICA, INC.**  
5301 Blue Lagoon Drive, Suite 250 Miami, FL 33126, U.S.A.  
**OLYMPUS (CHINA) CO., LTD.**  
A8F, Ping An International Financial Center, No. 1-3, Xinyuan South Road, Chaoyang District, Beijing, China, 100027

www.olympus.com

Printed in Japan M1756E-062012



## ADVANCE TO A HIGHER LEVEL OF LIVE CELL RESEARCH, WITH THE IX3

The new IX3 is a highly expandable platform for live cell imaging designed with the scientist's workflow in mind.

Built on a robust foundation and able to grow as your needs evolve, the IX3 features flexible construction with an easy-access light path and offers high-definition widefield imaging with minimal loss of light.

Equipped with a camera, the IX3 provides fast user-friendly, high resolution digital imaging with high reproducibility.



## EXPANDABLE TO GROW WITH YOUR RESEARCH



The fully-motorized and automated IX83 along with the semi-motorized IX73, are designed to satisfy a myriad of research needs. Each model is available as a one-deck system with ergonomic low stage height or as a two-deck system. With additional modules providing expanded functionality, both microscopes provide the ability to enable a multitude of imaging techniques, ranging from long-term time-lapse imaging and other demanding cutting edge techniques to casual documentation. No matter what the task, the IX3 series delivers the performance and expandability needed to accommodate the demands of tomorrow.

The left frame port on the IX83 provides ready access to the light-path making it easy to add or change modules. A variety of deck modules may be easily changed to supply added functions. Available modules include: Fluorescence filter turrets, side ports, magnification changer and more. Modules can be mounted with ease and allow users to build a single, uniquely flexible system. The IX3-ZDC module with its own specialized port is available for IX83 systems to maintain continuous focus throughout extended time-lapse use.

### IX83: Two-deck System



Enables high-speed, fully automated device selection during live cell research including time-lapse imaging. Two decks offer excellent expandability.

### IX83: One-deck System



An intelligent, motorized microscope that can be equipped with the IX3-ZDC to create a new standard for live cell imaging.

### IX73: One-deck System



A microscope designed with emphasis on working efficiency for documentation, routine testing and other tasks.

### IX53: One-deck System



An outstanding microscope delivering cost efficiency for brightfield and fluorescence applications.

# RELIABLE HIGH RESOLUTION IMAGES THAT ARE CLEAR AND BRIGHT

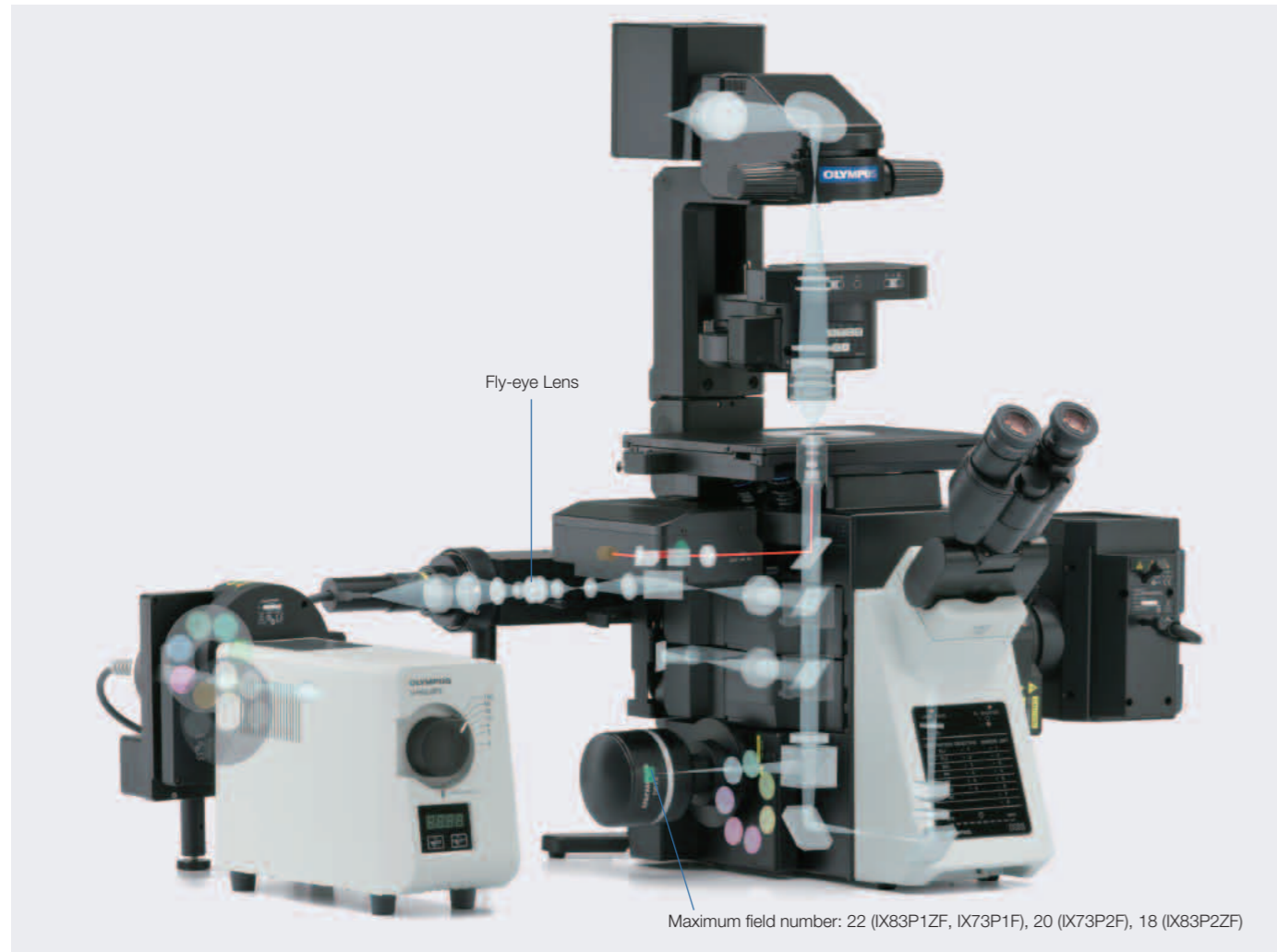

Olympus UIS2 infinity-corrected optics provide bright, high resolution images from ultraviolet to near-infrared.

The system ensures high optical transmittance with a broad range of objectives providing wide chromatic correction and high resolution, as well as high S/N primary images regardless of the observation method. The wide field of view and fly-eye lens system provide uniform fluorescence images and enable the use of sCMOS cameras with large chips.

## Excellent Image

### Apochromatic Objectives Enable High Resolution Observation of Phase Contrast and Fluorescence

Phase contrast apochromatic objectives (UPLSAPO100×OPH, PLAPON60×OPH) enable high-precision observation free from optical axis displacement—even during simultaneous observation of phase contrast and fluorescence, negating the need to change the objective when switching methods.

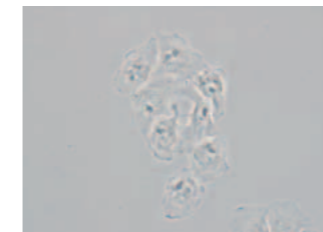

HeLa cells

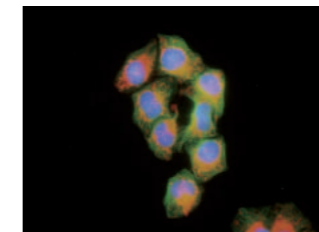

### Silicone Objectives\* Enable High Resolution Observation of Deep Live Cells

These high-NA objectives (UPLSAPO30×S and UPLSAPO60×S) use silicone oil as an immersion medium with a refractive index ( $n \approx 1.40$ ) close to that of living tissue ( $n \approx 1.38$ ) normally investigated in live cell imaging. As a result, these objectives deliver high resolution observation with minimal spherical aberration that is commonly caused by a refractive index mismatch when viewing deep inside living tissue.



### Special Objective Available for iPS/ES and Floating Cell Observation

This high-NA phase contrast objective (UCPLFLN20×PH) is especially suited for the observation of plastic dishes. It enables phase contrast observation of the cell proliferation process, for example, and delivers differentiation across a wide area in high resolution.

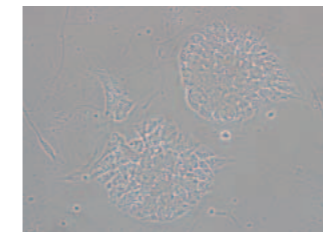

Phase contrast image of mouse ES cells

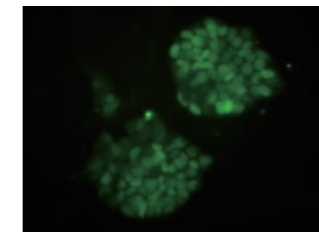

Immunofluorescence staining for Nanog



### Bright, Uniform Fluorescent Illumination

The fluorescence illuminator (IX3-RFALFE) incorporates a fly-eye lens system to provide an even distribution of fluorescence illumination.

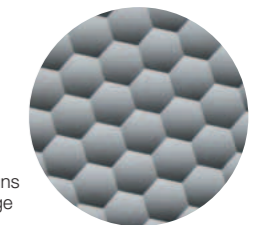

Surface of a Fly-eye Lens System, Enlarged Image

### High S/N Fluorescent Mirror Units that Efficiently Detect Fluorescence Signals

All fluorescence mirror units feature filters treated with a coating specially developed to minimize noise by absorbing more than 99% of stray light, while the sharp performance and high transmittance of the mirror units ensure efficient fluorescence signal detection.

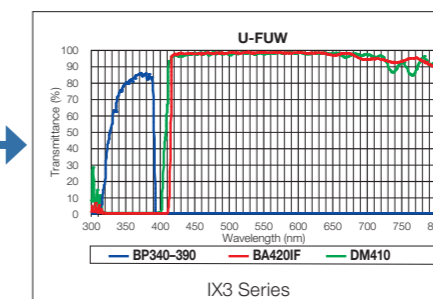
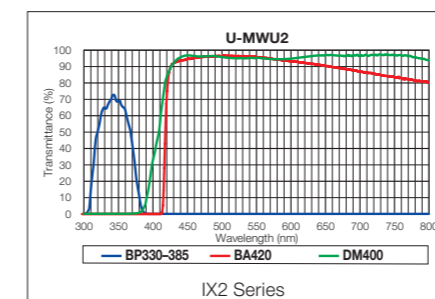

### LED Transmitted Illumination

With its perfect color reproduction and low heat generation, this LED illumination is ideal for time-lapse imaging.





# INTUITIVE AND ERGONOMIC CONTROL OVER MICROSCOPE PERFORMANCE



The IX3 imaging system incorporates a range of advanced technologies to enable fine control of your imaging. As a result, it allows researchers to refine complex sequences of operations into workflows with speed and comfort, eliminating burden on the observer and minimizing cell damage.

A repositionable controller can be located comfortably close to hand, while Olympus cellSens\* imaging software enables advanced control of functions. There is also an innovative, user-friendly touch panel that makes digital control simple and accurate, even when working under darkroom conditions. The IX3-ZDC Z-drift compensation system employs a near-infrared light to minimize cell damage while enabling instant focus.

## Smart Control

### Switch Observation Methods with a Tap of the Touch Panel

A press of a touch panel is all it takes to change observation settings, with automatic controls enabling switching of optical components, aperture adjustment and exposure.



### ZDC One-shot Function Detects Focus Fast, Even in High Magnification Observation

IX3-ZDC focus detection and tracking can be performed via the innovative touch panel independent of software. There's also a focus search function supported by a cell-safe, near-infrared laser enabling instant focusing on samples—even at high magnification.



Just Touch the Panel

For Instant Focus

### Intuitive Microscope and XY Stage Controllers

The combination of the U-MCZ and XY-controller make it possible to provide the familiarity of conventional handle operation for confident working even in a darkroom.



### Microscope Configuration Recall (Olympus cellSens)

The system saves microscope configurations alongside image data through incorporation of a readout function that utilizes motorized units and coded units. With this advanced system, a wide range of settings can be recalled to recreate the desired imaging conditions, thus creating an easy-to-use reproducible high-end imaging system.

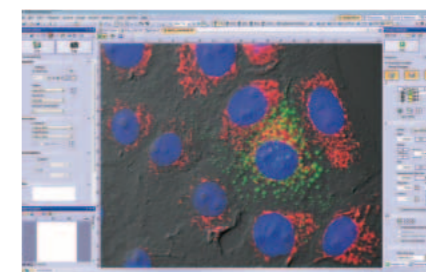

Olympus cellSens Imaging Software

## Operator-friendly Design

### Smooth Tracking at High Magnification

The IX3-SVR manual stage features a smooth positioning system which enables the easy tracking of cells even in high magnifications. The user settable position limits immobilizes the stage, ensuring that the observation position is maintained during operations such as reagent application, even if the stage is inadvertently touched. It is also possible to remove 35mm dishes from the stage, place them in an incubator for culturing and return them to the stage—repositioning the exact location of the cells within the field of view.



### Koehler Illumination Control Via the Frontal Condenser Knob

Using a condenser lock and the front-located control knobs, the condenser can be moved and easily reset to Koehler Illumination.



### Frame Construction Prevents Optical System Contamination

A catch tray under the nosepiece prevents damage to the microscope frequency caused by contamination through spilled liquids and simplifies maintenance.





# IDEAL OBSERVATION AND CAPTURE OF TIME-LAPSE IMAGES

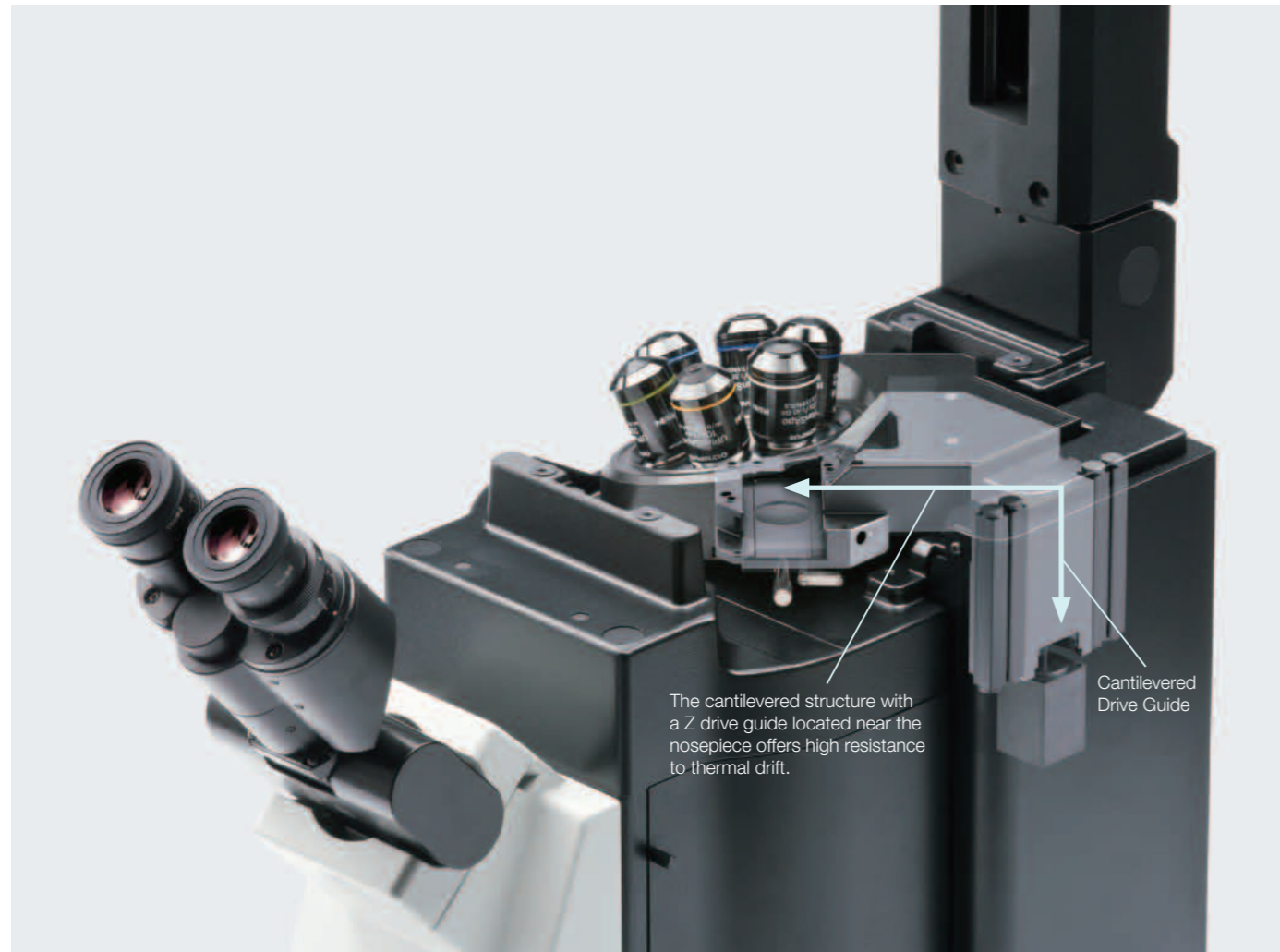

With new frame architecture and focus drive design, the IX3 system offers enhanced rigidity that reduces the impact of vibration and heat. It maintains desired positions along X, Y, and Z axes to allow reliable time-lapse imaging. The real-time Z-drift compensation system capabilities of the IX3-ZDC combine with the Olympus ultrasonic stage-capable of multipoint imaging to enable capturing high-precision multipoint time-lapse images that are never out-of-focus or misaligned.

Box-type and onstage incubators are also available to enable time-lapse observation while maintaining the viability of live cells.

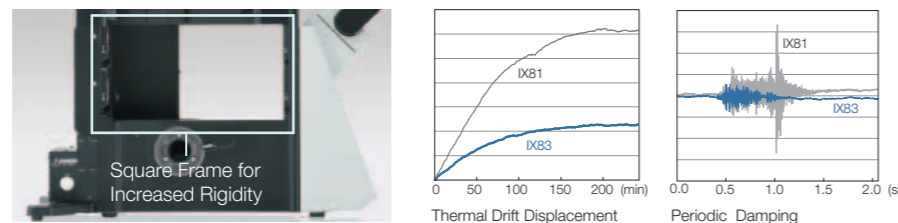

## Accuracy

### Z-drift Compensation System

The IX3-ZDC uses low phototoxicity IR light to detect the correct focus position as set by the user. One-shot AF mode allows several focus positions to be set as desired for deeper samples, enabling efficient Z-stack acquisition in multi-position experiments. Continuous AF mode keeps the desired plane of observation precisely in focus, avoiding focus drift due to temperature changes or the addition of reagents, making it ideal for measurements such as TIRF that requires more stringent focusing.

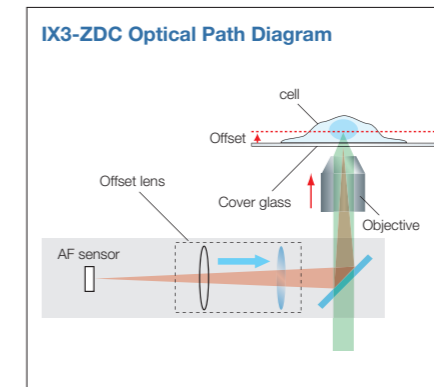

### Time-lapse Observation Images Using ZDC Example

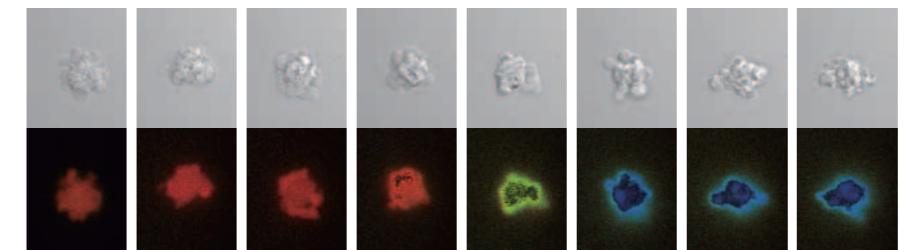

Apoptosis in cultured human ES cells, photographed at 2-minute intervals over 5 hours. (Top row: DIC imaging of physical changes; Bottom row: FRET imaging of Caspase-3 action)

Image data courtesy of:  
Masatoshi Ohgushi, Ph.D.  
Yoshiki Sasai M.D., Ph.D.  
Human Stem Cell Technology Unit, RIKEN Research Center for Developmental Biology

Reference material:  
Ohgushi, M. et al. Molecular Pathway and Cell State Responsible for Dissociation-Induced Apoptosis in Human Pluripotent Stem Cells. Cell Stem Cell 7, 225-239(2010).

### Low Thermal Drift Ultrasonic Stage with Multipoint Registration

The Olympus ultrasonic stage enables precise movement of specimens, while multi point registration enables time-lapse imaging with outstanding positional accuracy.

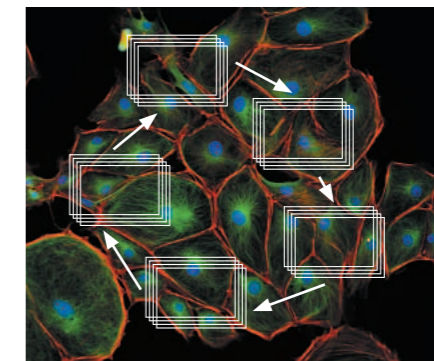

### Maintain Cell Viability Over an Extended Period of Time

Box-type incubator enables time-lapse observations over a period of several days, while the microscope CO<sub>2</sub> incubator can be fitted to the stage for two-day time-lapse observations maintaining cell activity to significantly improve the reliability of time-lapse observation.



### CO<sub>2</sub> Stage Top Incubator

Precise controls maintain a constant environment within the dish or well plate controlling thermally, humidity and CO<sub>2</sub> concentration.



IX3D CO<sub>2</sub> Incubator  
(Manufactured by Tokai Hit CO.,Ltd)

### Incubator

A box-type incubator keeps the microscope temperature stable while safely enclosing many components.

# SOPHISTICATED IMAGING OPTIONS WITH INTERCHANGEABLE OPTICAL MODULES



A diverse range of units is available for the Olympus IX3 microscope system, bringing greater efficiency to everything from casual observation to serious imaging. Simple cassette-like insertion into the deck makes it easy to mount fluorescence mirror turrets, a right side port with C-mount, an encoded magnification changer, reflected light fluorescence illuminators and other desired units.

To provide more flexibility, the two-deck system allows the simultaneous mounting of two illumination units. The IX3 system can also be isolated from vibration sources through the combined use of a new line of high-speed filter wheels and light guide light sources. Upgrades are available to allow the IX3 to meet the needs of a wide range of other applications.

## Deck Units/Fast Speed Units

### Motorized Fluorescence Mirror Turret (IX3-RFACA)

A non-click turret fitted with 8 mirror units delivers smooth, fast switching. Mirror units can be used with 25mm diameter filters or 32mm diameter filters. No tool use is required to change mirror units, which can be opened with ease.

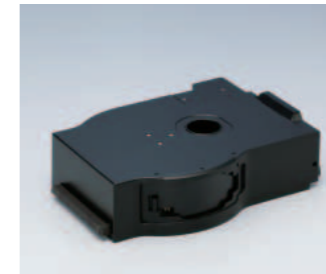

IX3-RFACA

### Right Side Port with C-mount (IX3-RSPC)

A right side port with a C-mount (field number of 11) allows the light-path switching component to be fitted with up to two mirror units, enabling the construction of customized systems for applications such as split imaging.



IX3-RSPC

### Coded Intermediate Magnification Changer (IX3-CAS)

Magnification can be changed between 1x, 1.6x and 2x by smooth lever operation. Since the system incorporates coded functionality, information on intermediate magnifications is saved with image data.



IX3-CAS

### Motorized Fast Filter Wheel (U-FFW)/

### Motorized Fast Filter Wheel for Emission (U-FFWEM)/ Motorized Fast Shutter (U-FSHU)

Filter wheels can be switched between filters in just 60 milliseconds, while shutters can be opened and closed in just 26 milliseconds. The IX83 is capable of controlling up to six filter wheels and four shutters.



U-FFW



U-FFWEM



U-FSHU

## Fluorescence System

### Reflected Light Fluorescence Illuminators for Your Specific Application

Choose the illuminator best suited to meet each need, such as multicolor fluorescence observation or photoactivation. An L-shaped fluorescence illuminator with a fly-eye lens system provides bright, consistent illumination without adjustment, an L-shape fluorescence illuminator is equipped with a field iris diaphragm and aperture iris diaphragm, and a straight-through fluorescence illuminator is available for applications demanding intense excitation light. A wide range of light sources are available, including light guide light sources and lamp houses compatible with both 100W mercury and 75W xenon illumination.

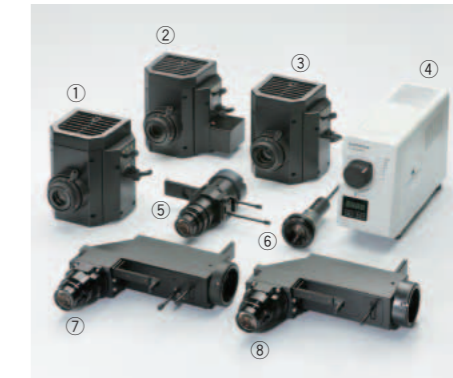

- ① U-LH100HG
- ② U-LH75XEAP0
- ③ U-LH100HGAP0
- ④ U-HGLGPS
- ⑤ IX3-RFA
- ⑥ U-LLGAD
- ⑦ IX3-RFAL
- ⑧ IX3-RFALFE

## Motorized Units/Coded Units

### A Cost-efficient Way to Upgrade to a Motorized Microscope

A wide range of motorized and encoded units are available, including an 8-position motorized fluorescent mirror turret, an encoded fluorescence mirror turret, a motorized 6-position nosepiece, an encoded 6-position nosepiece, a motorized long working distance universal condenser, filter wheels and shutters. Units can also be added for specific purposes at any point—improving operation at a minimum cost.



- ① U-FFWEM
- ② IX3-LWUCDA
- ③ U-FFW
- ④ U-FSHU
- ⑤ IX3-RFACA
- ⑥ IX3-D6RES
- ⑦ IX3-D6REM



# OPTIMIZED IMAGE ACQUISITION ACCORDING TO WORKFLOW

## Olympus cellSens Imaging Software

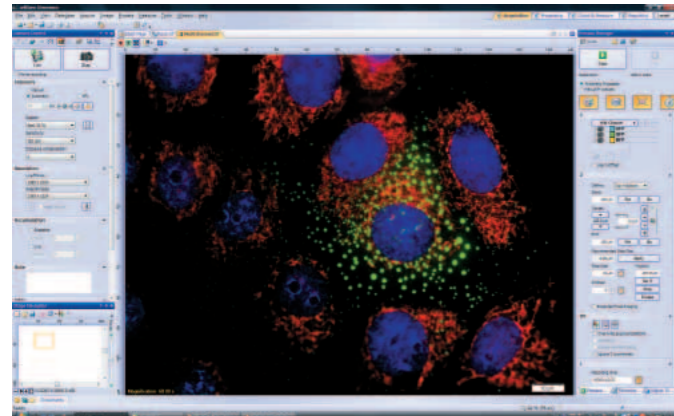

Olympus cellSens imaging software is available in three packages to meet individual workflow needs. "Entry" is used for simple image acquisition. "Standard" provides simple operation for imaging documentation and "Dimension" allows control of the complete workflow from image capture to analysis.

*cellSens software is not for clinical diagnostic use.*

### 2D Deconvolution

This useful feature eliminates blur from single plane images. Processing can be carried out multiple times and the results can be adjusted while viewing them on the screen. A 3D deconvolution module is also available for use on multi-plane images.

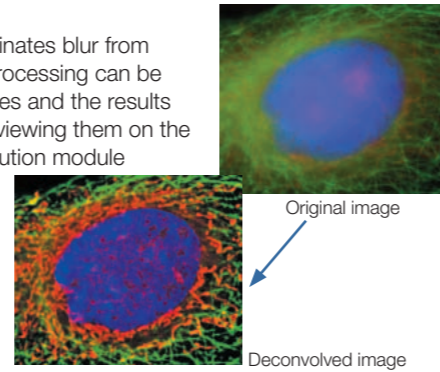

### Well Navigator

Enables the simple setting of locations and observation orders by selecting to the wells under observation. Comments can also be inserted for individual wells to further speed workflow.

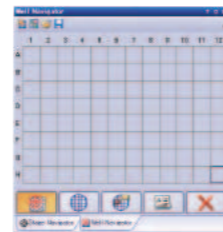

## cell<sup>^</sup>TIRF System



### Quad-wavelength Multiple TIRF Image Capture

Accurate, motorized control of the laser's angle of incidence enables optimum adjustment of the light emitted at each wavelength. This system allows four lasers to be used simultaneously to capture four different wavelengths (ranging from 405 nm to 640 nm), while seamlessly switching between multicolor TIRF imaging and fluorescence. What's more, the primary laser path is equipped with a point FRAP optical solution system that can also be used for kinetic measurements such as molecular diffusion, bonding and velocity determination.

*cell<sup>^</sup>TIRF is a class 3B laser product.*

### NA 1.7 TIRF Objective

The NA 1.7 APON100xHOTIRF\* objective expands the adjustable range for production of evanescent fields, enabling the user to form thin evanescent fields by simply adjusting the angle of incidence. High NA objectives for TIRF from 60x to 150x are also available.



### TIRF Image Acquisition with High Resolution and a High Frame Rate

TIRF observation demands more accurate focusing. To meet this demand, the IX83 two-deck system can be combined with the IX3-ZDC to deliver live imaging at a high frame rate, while maintaining accurate real-time focus.

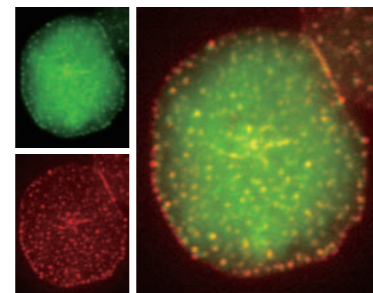

Colocalization of the Dynein Complex with T Cell Receptor Microclusters

Image data courtesy of:  
Akiko Hashimoto-Tane, Ph.D.  
Takashi Saito, Ph.D.  
Laboratory for Cell Signaling,  
RIKEN Research Center for Allergy  
and Immunology

Reference material:  
Akiko Hashimoto-Tane, Takashi Saito, *et al.* (2011). Dynein-Driven Transport of T Cell Receptor Microclusters Regulates Immune Synapse Formation and T Cell Activation. *Immunity* 34, 919-931.  
•Images shown left acquired by IX81.

## Objective specifications

UIS2 objective		NA	W.D. (mm)	FN	Cover glass thickness (mm)	Immersion	Spring	Correction ring	Iris diaphragm	Water proof & oil proof function
UPLSAPO	UPLSAPO 4x	0.16	13	26.5	—					
	UPLSAPO 10x2	0.40	3.1	26.5	0.17					
	UPLSAPO 20x	0.75	0.6	26.5	0.17		✓			
	UPLSAPO 20x0	0.85	0.17	26.5	—	Oil	✓			✓
	UPLSAPO 30xS	1.05	0.8	22	0.13-0.19	Silicone		✓		✓
	UPLSAPO 40x2	0.95	0.18	26.5	0.11-0.23		✓	✓		
	UPLSAPO 60xW	1.20	0.28	26.5	0.13-0.21	Water	✓	✓		✓
	UPLSAPO 60x0	1.35	0.15	26.5	0.17	Oil	✓			✓
	UPLSAPO 60xS	1.30	0.3	22	0.15-0.19	Silicone	✓	✓	✓	✓
	UPLSAPO 100x0	1.40	0.13	26.5	0.17	Oil	✓			✓
	UPLSAPO 100xOPH	1.40	0.13	26.5	0.17	Oil	✓			✓
PLAPON	PLAPON 60x0	1.42	0.15	26.5	0.17	Oil	✓			✓
	PLAPON 60xOSC	1.40	0.12	22	0.17	Oil	✓			✓
	PLAPON 60xOPH	1.42	0.15	26.5	0.17	Oil	✓			✓
UPLFLN	UPLFLN 4x	0.13	17	26.5	—					
	UPLFLN 10x2	0.30	10	26.5	—					
	UPLFLN 20x	0.50	2.1	26.5	0.17		✓			
	UPLFLN 40x	0.75	0.51	26.5	0.17		✓			
	UPLFLN 40x0	1.30	0.2	26.5	0.17	Oil	✓			✓
	UPLFLN 60x	0.90	0.2	26.5	0.11-0.23		✓	✓		
	UPLFLN 60xOI	1.25-0.65	0.12	26.5	0.17	Oil	✓		✓	✓
	UPLFLN 100xO2	1.30	0.2	26.5	0.17	Oil	✓			✓
	UPLFLN 100xOI2	1.3-0.6	0.2	26.5	0.17	Oil	✓		✓	✓
PLFLN	PLFLN 100x	0.95	0.2	26.5	0.14-0.2		✓	✓		
UCPLFLN	UCPLFLN 20x	0.7	0.8-1.8	22	0-1.6			✓		
	UCPLFLN 20xPH	0.7	0.8-1.8	22	0-1.6			✓		
LUCPLFLN	LUCPLFLN 20x	0.45	6.6-7.8	22	0-2			✓		
	LUCPLFLN 40x	0.60	2.7-4	22	0-2			✓		
	LUCPLFLN 60x	0.70	1.5-2.2	22	0.1-1.3			✓		
	LUCPLFLN 20xPH	0.45	6.6-7.8	22	0-2			✓		
	LUCPLFLN 20xRC	0.45	6.6-7.8	22	0-2			✓		
	LUCPLFLN 40xPH	0.60	3.0-4.2	22	0-2			✓		
	LUCPLFLN 40xRC	0.60	3.0-4.2	22	0-2			✓		
	LUCPLFLN 60xPH	0.70	1.5-2.2	22	0.1-1.3			✓		
UPLFLN-PH	UPLFLN 4xPH	0.13	17	26.5	—					
	UPLFLN 10x2PH	0.30	10	26.5	—					
	UPLFLN 20XPH	0.50	2.1	26.5	0.17		✓			
	UPLFLN 40XPH	0.75	0.51	26.5	0.17		✓			
	UPLFLN 60XOIPH	1.25-0.65	0.12	26.5	0.17	Oil	✓			✓
	UPLFLN 100XO2PH	1.30	0.2	26.5	0.17	Oil	✓			✓
UPLFLN-PHP	UPLFLN 4xPHP	0.13	16.4	22	—					
CPLFLN	CPLFLN 10xPH	0.30	9.5	22	1					
	CPLFLN 10xRC	0.30	9	22	1.5					
LCACHN	LCACHN 20xPH	0.40	3.2	22	1					
	LCACHN 20xPHP	0.40	3.2	22	1					
	LCACHN 20xRC	0.40	2.8	22	1.5					
	LCACHN 40xPH	0.55	2.2	22	1					
	LCACHN 40xPHP	0.55	2.2	22	1					
	LCACHN 40xRC	0.55	1.9	22	1.5					
CACHN & CPLN	CACHN 10xPHP	0.25	8.8	22	—					
	CPLN 10xPH	0.25	10	22	1					
	CPLN 10xRC	0.25	9.7	22	1.5					
UAPON 340	UAPON 20xW340	0.70	0.35	22	0.17	Water	✓			✓
	UAPON 40xO340	1.35	0.1	22	0.17	Oil	✓			✓
	UAPON 40xW340	1.15	0.25	22	0.13-0.25	Water	✓	✓		✓
TIRF	APON 60xOTIRF	1.49	0.1	22	0.13-0.19	Oil		✓		✓
	APON 100xHOTIRF*	1.70	0.08	22	0.15	Oil		✓		✓
	UAPON 100xOTIRF	1.49	0.1	22	0.13-0.19	Oil		✓		✓
	UAPON 150xOTIRF	1.45	0.08	22	0.13-0.19	Oil		✓		✓

\*HIGHINDEX-CG cover glass and dedicated immersion oil required.



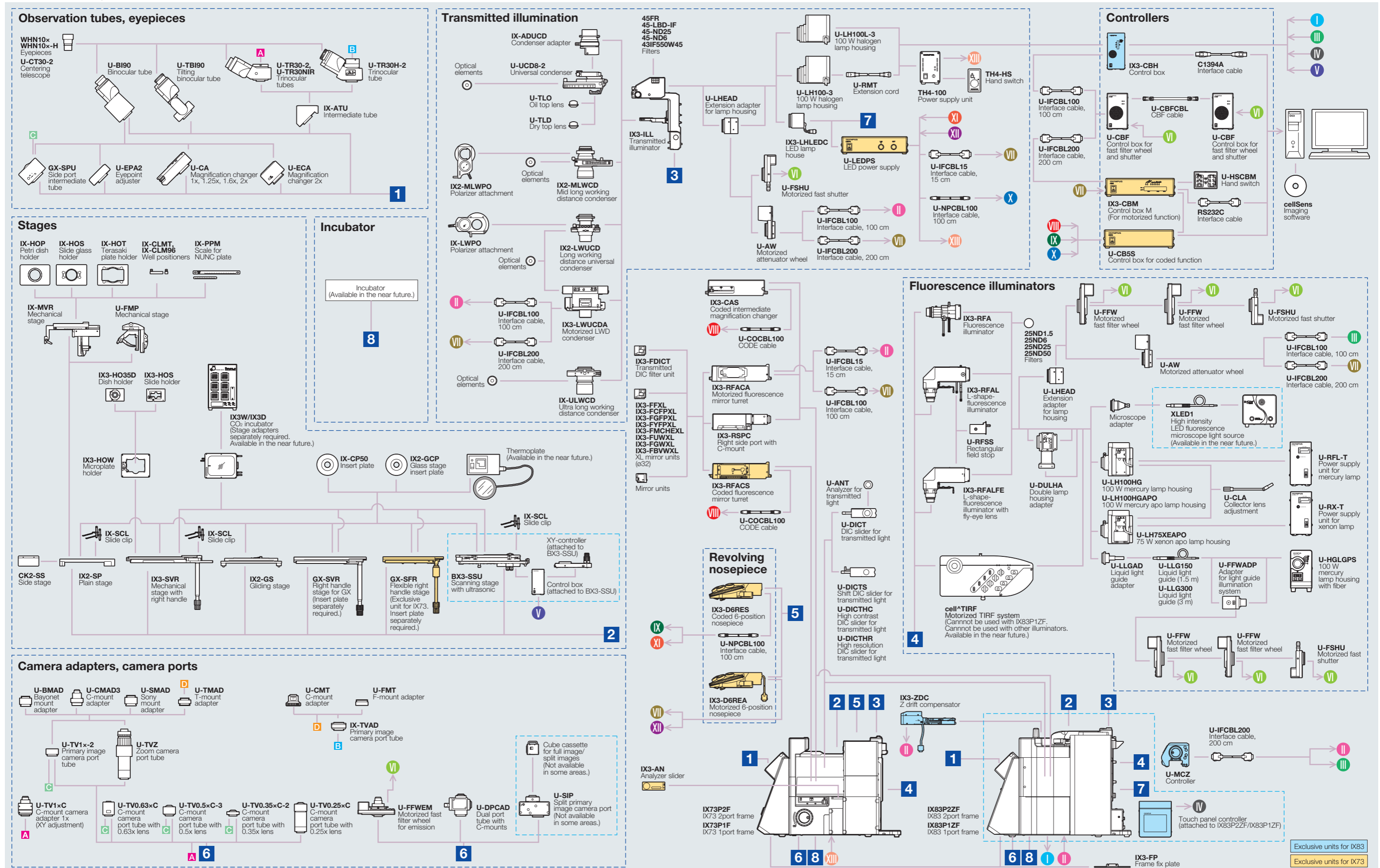

**IX3 specifications**

		IX83	IX73	IX53
Microscope frame	Optical system	UIS2 optical system		
	Revolving nosepiece	<ul style="list-style-type: none"> <li>Motorized sextuple revolving nosepiece (DIC slider attachable), simple waterproof structure</li> </ul>	<ul style="list-style-type: none"> <li>Motorized sextuple revolving nosepiece (DIC slider attachable), simple waterproof structure</li> <li>Coded sextuple revolving nosepiece (DIC slider attachable), simple waterproof structure</li> </ul>	<ul style="list-style-type: none"> <li>Sextuple revolving nosepiece, simple waterproof structure</li> </ul>
	Focus	Stroke: 10.5mm Minimum increment: 0.01µm, Maximum nosepiece movement speed: 3mm/s	Stroke: 10mm	Stroke: 10mm
	Light path selection	Motorized 0:100/50:50/100:0 (Left side port: BI port)	0:100/50:50/100:0 (Left side port: BI port)	50:50 (Left side port: BI port)
Transmitted light illuminator	Pillar tilt mechanism (30° inclination angle, with vibration reducing mechanism), Condenser holder (with with 88mm stroke, refocusing mechanism), Field iris diaphragm adjustable, 4 filter holders Light source: •12V 100W halogen bulb (pre-centered) • High color reproductive LED light source			<ul style="list-style-type: none"> <li>•30W halogen illuminator: Detachable condenser lens system (NA 0.3, W.D. 72mm), single filter holder aperture iris diaphragm adjustable</li> <li>•100W halogen illuminator: Pillar tilt mechanism (30° inclination angle, with vibration reducing mechanism), Condenser holder (with 88mm stroke, refocusing mechanism) Field iris diaphragm adjustable, 4 filter holders</li> </ul>
Observation tube	Widefield (FN 22)	•Widefield tilting binocular •Widefield binocular •Widefield trinocular		•Widefield tilting binocular •Widefield binocular
Stage	Scanning stage with ultrasonic	Stage stroke: X: 76mm x Y: 52mm, maximum stage movement speed: 30mm/s		—
	Mechanical stage with right handle	Stage stroke: X: 114mm x Y: 75mm, stage position locking function		
	Right handle stage	Stage stroke: X: 50mm x Y: 50mm		
	Flexible right handle stage	—	Stage stroke: X: 50mm x Y: 50mm	
	Gliding stage	Upper circular stage 360° rotatable, 20mm (X/Y) travel		
Condenser	Plain stage	232mm (X) x 240mm (Y) stage size, stage insert plate exchangeable (ø110mm)		
	Motorized long working distance condenser	W.D. 27mm, NA 0.55, motorized turret with 7 position slots for optical devices (3 positions for ø30mm and 4 positions for ø38mm), motorized aperture and polarizer		—
	Long working distance universal condenser	NA 0.55, W.D. 27mm 5 positions for optical devices (3 positions for ø30mm and 2 position for ø38mm)		
	Long working distance relief contrast	NA 0.5, W.D. 45mm, 4 positions for optical devices (for ø50mm, Relief Contrast optical devices rotatable)		
Fluorescence illuminator	Ultra long working distance	NA 0.3, W.D. 73.3mm, 4 positions for optical devices (for ø29mm)		
	L-shape-fluorescence illuminator with flyeye lens	L-shaped design with exchangeable FS module		
	L-shape-fluorescence illuminator	L-shaped design with exchangeable FS and AS modules		
Fluorescence mirror turret	Fluorescence illuminator	Straight design with field iris diaphragm		
	Motorized fluorescence mirror turret	Motorized turret with 8 positions, built-in shutter, simple waterproof structure		—
	Coded fluorescence mirror turret	—	Coded 8 positions turret, built-in shutter, simple waterproof structure	
Fluorescence light source	Fluorescence mirror turret	—	—	Turret with 8 positions, built-in shutter, simple waterproof structure
		•130W Hg light guide illumination •100W Hg apo lamp housing and transformer •100W Hg lamp housing and transformer •75W Xe lamp housing and transformer		
Focus compensator	Z drift compensator	Offset method (Focus search, one-shot focus, continuous focus), Class 1 laser product		
Filter wheel/shutter	Motorized fast filter wheel	High speed mode 60ms, Low vibration mode 100ms (rotation time until next hole on the wheel)		—
	Motorized fast filter wheel for emission	High speed mode 60ms, Low vibration mode 100ms (rotation time until next hole on the wheel) C-mount adapter and bayonet mount adapter are enclosed		—
	Motorized fast shutter	High speed mode 26.2ms, Low vibration mode 60ms (rotation time on one way)		—
	Motorized attenuator wheel	Time to shift another filter 300ms (rotation time until next hole on the wheel)		—
Operating environment	<ul style="list-style-type: none"> <li>• Indoor use</li> <li>• Ambient temperature: 5 °to 40°C (41° to 104°F)</li> <li>• Maximum relative humidity: 80% for temperatures up to 31°C (88°F), decreasing linearly through 70% at 34°C (93°F), 60% at 37°C (99°F), to 50% relative humidity at 40°C (104°F)</li> <li>• Supply voltage fluctuations: Not to exceed ±10% of the normal voltage</li> </ul>			

Motorized or coded units are designed for the IX3 series use in industrial environments for the EMC performance (IEC61326-1 Class A device). Using it in a residential environment may effect other equipment in the environment.

**Dimensions**

